

# Birlea

Suppliers of inspiration

## Assembly Instructions

---

*Thank you* for  
purchasing a  
Birlea product.

For a chance to win a *Love 2 Shop* voucher simply post a picture of your new product on your preferred social channels tagging Birlea Furniture and using the hashtag **#ShareYourStyle** and **#Birlea**. One winner will be selected at random each month.

*To view our full terms and conditions please visit our website. [www.birlea.com](http://www.birlea.com)*

---

### **Are you happy with your purchase?**

**Yes:** That's great, we would love to hear more from you. Please leave us a review on our social media channels or Trustpilot. Your feedback will be greatly appreciated.

**No:** If for any reason there is something missing, indifferent or incorrect with your order, please contact the retailer you purchased the item from. We will work with the retailer to resolve your issue as quickly as possible.



[www.birlea.com](http://www.birlea.com)

## **ASSEMBLY INSTRUCTIONS** **120CM HAMPSTEAD BED OAK**

**IMPORTANT : READ THESE INSTRUCTIONS CAREFULLY BEFORE ATTEMPTING TO ASSEMBLE OR USE YOUR 120CM HAMPSTEAD BED OAK.**

**PLEASE KEEP THESE INSTRUCTIONS FOR FUTURE REFERENCE.**

### **ASSEMBLY:**

Assembly should be carried out with this item laying flat, not standing upright.

Assemble on a soft, clean surface to prevent damages.

To erase the numbers printed on the pieces, use the rubber inside the accessories pack.

### **HEALTH & SAFETY:**

**DO NOT** use this product if any parts are missing, damaged or worn.

**DO NOT** use this product unless all fixings are secured.

Always use on a level, even surface.

### **CARE & MAINTENANCE:**

Periodically check all screws & fixings to ensure they are secure.

**DO NOT** push this product as this will cause damage.

Always lift this product with two people to repositions.

Keep any sharp objects away from this product.

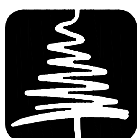

**Birlea**

Suppliers of inspiration

[www.birlea.com](http://www.birlea.com)

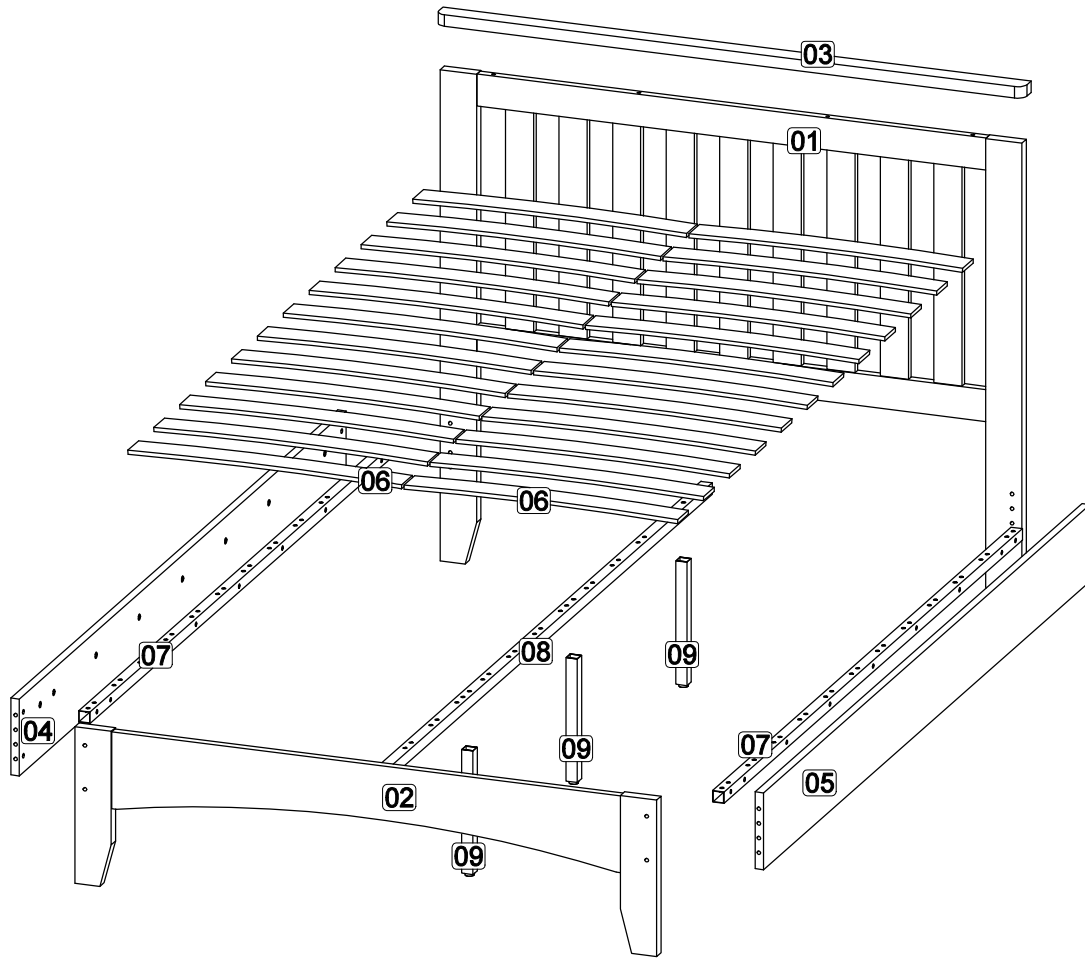











**Parts List**

Part	Description	Box	Qty
01	Headboard	1	1
02	Footboard	1	1
03	Headboard top tray	2	1
04	Bed side ( Left )	2	1
05	Bed side ( Right )	2	1
06	Bend LVL wood slat	2	24
07	Metal side bar	2	2
08	Metal center bar	2	1
09	Metal center plate	2	3

**\*\* You will need a small mallet and a screwdriver for assembly.**

**\*\* Some screws and wooden dowel may remain.**

**Hardware List ( BOX 2 )**

Part	Description	Qty
A1	Cam lock 	4
A2	Minifix screw 	4
B	M8 x 40mm Wood Dowel 	8
C	M3.5 x 16mm C.B Screw 	2
D	Allen key M4 	1
E	JCBC screw M6 x 35mm 	18
F	JCBC screw M6 x 50mm 	3
G	JCBC screw M6 x 60mm 	8
H	JRN Nut M6 x 10 x 13mm 	8
I	PVC Nail leg 5/8 	4
J	Plastic cap ( Single ) 	24
K	Plastic cap ( Center ) 	12

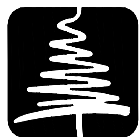

# Birlea

Suppliers of inspiration

**Step 1:** Prepare these parts for assembly using hardware parts A1, A2, B and I.

**DO NOT use any power tools as this may damage the frame and will invalidate any claim.**

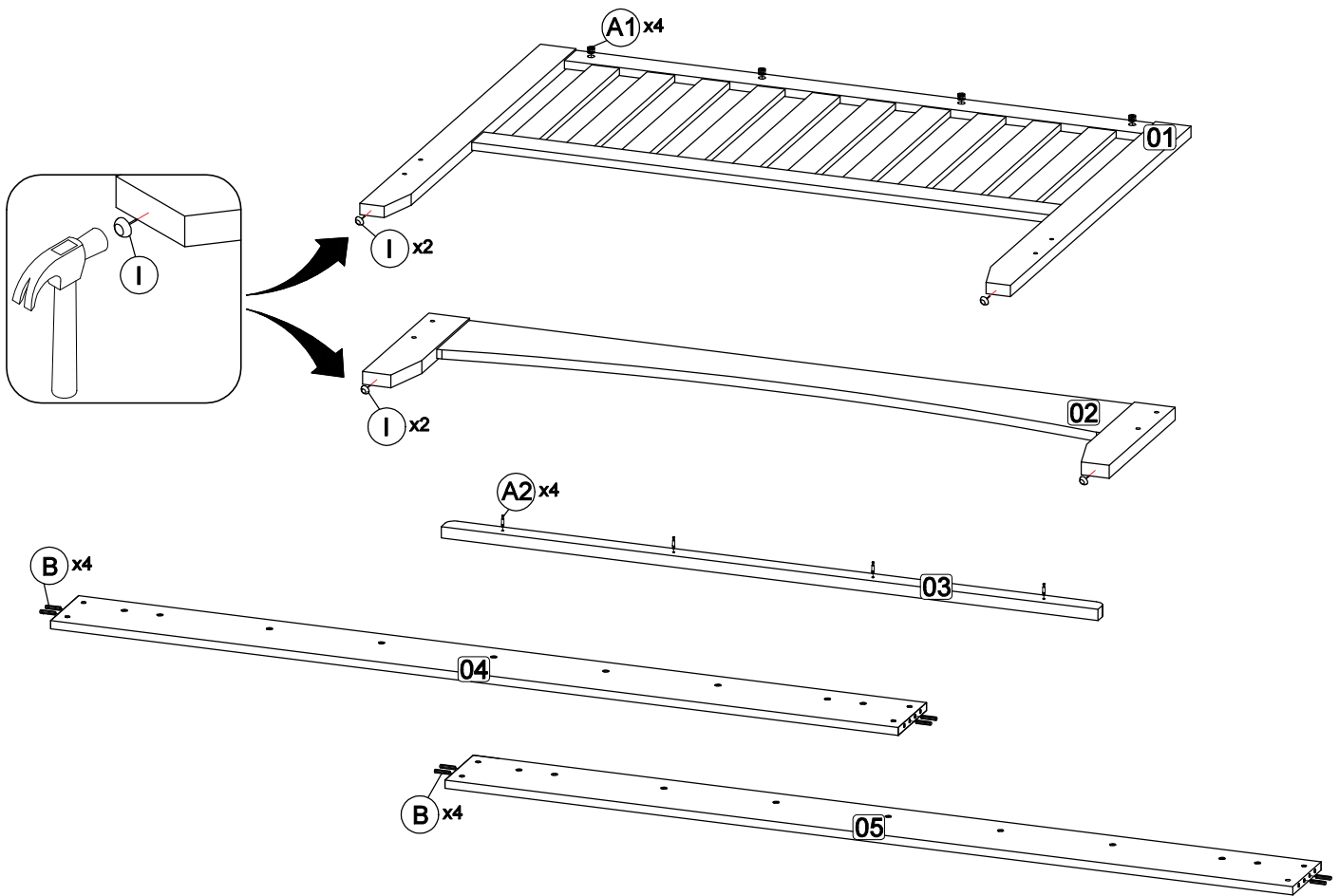

**Step 2:** Attach headboard top tray panel (3) to headboard panel (1) by using hardware A1 and A2 with a screwdriver (not provided).

**DO NOT use any power tools as this may damage the frame and will invalidate any claim.**

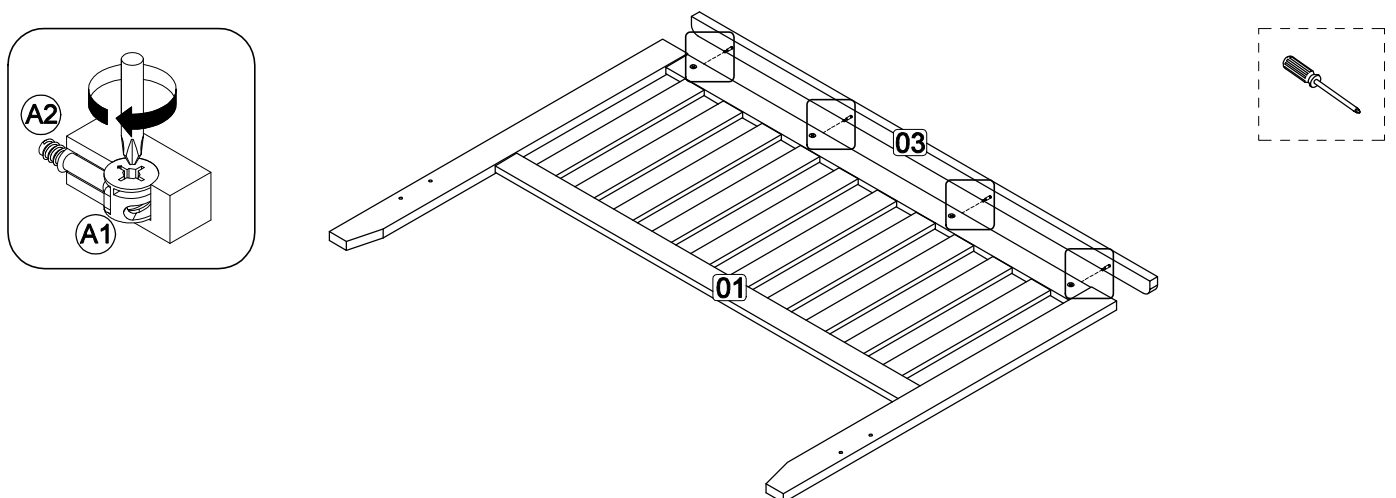

**Birlea**

Suppliers of inspiration

**Step 3: Attach metal side bar (7) to bed side (Left) (4) and bed side (Right) (5) using hardware D and E.  
DO NOT use any power tools as this may damage the frame and will invalidate any claim.**

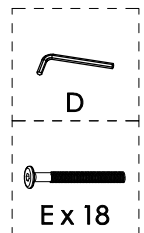
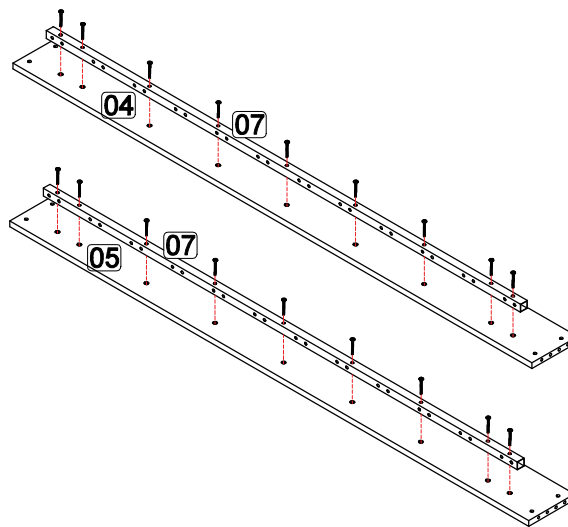
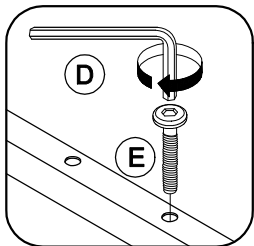

**Step 4: Insert hardware H into bedside panel (4) and (5) then attach headboard panel (1) and footboard (2) to bedside panel (4) and (5) by using hardware D and G.  
DO NOT use any power tools as this may damage the frame and will invalidate any claim.**

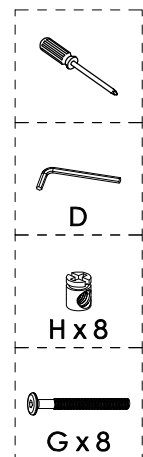
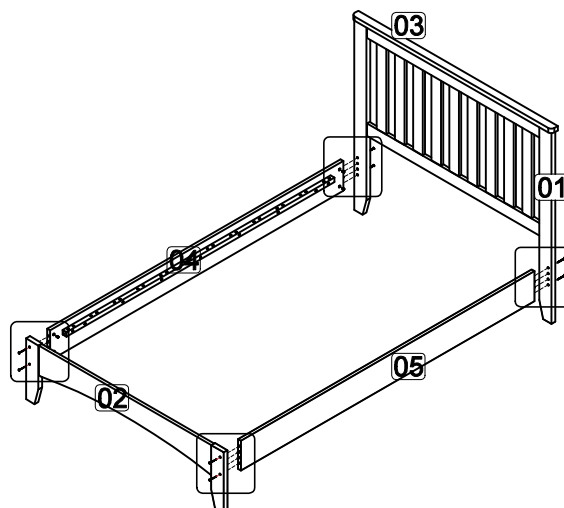
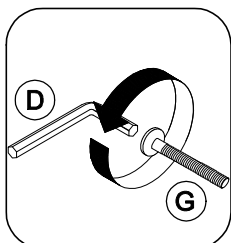
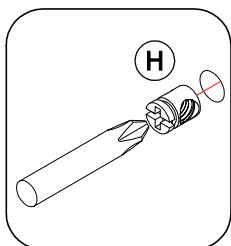

**Step 5: Attach metal center plate (9) to metal center bar (8) using hardware D and F.  
DO NOT use any power tools as this may damage the frame and will invalidate any claim.**

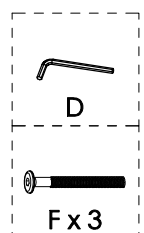
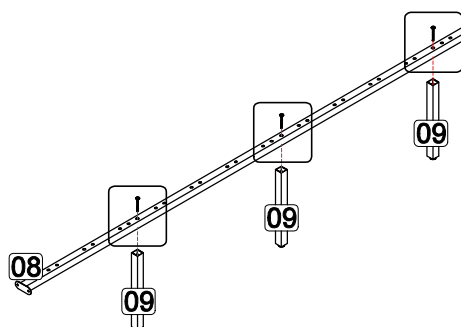
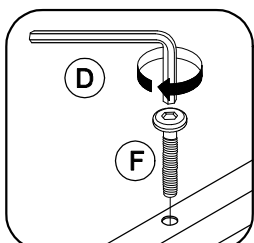

**Birlea**

Suppliers of inspiration

**Step 6:** Attach metal center bar (8) to footboard panel (2) using hardware C and screwdriver (not provided).  
**DO NOT use any power tools as this may damage the frame and will invalidate any claim.**

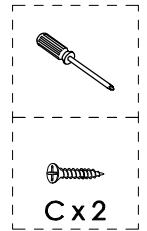
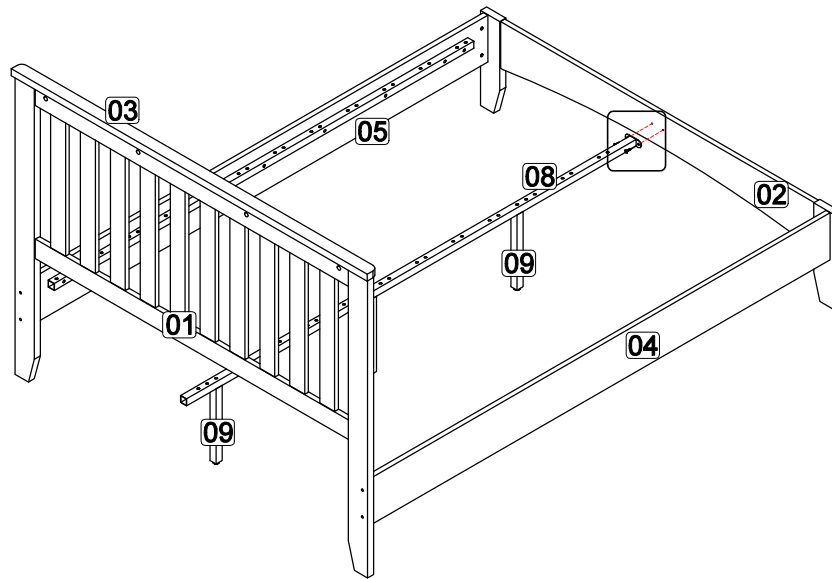
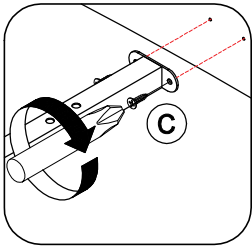

**Step 7:** Assemble hardware J and K to bend LVL wood slat (6) by hand.  
**DO NOT use any power tools as this may damage the frame and will invalidate any claim.**

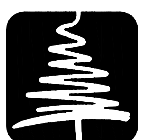
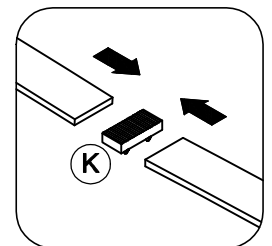
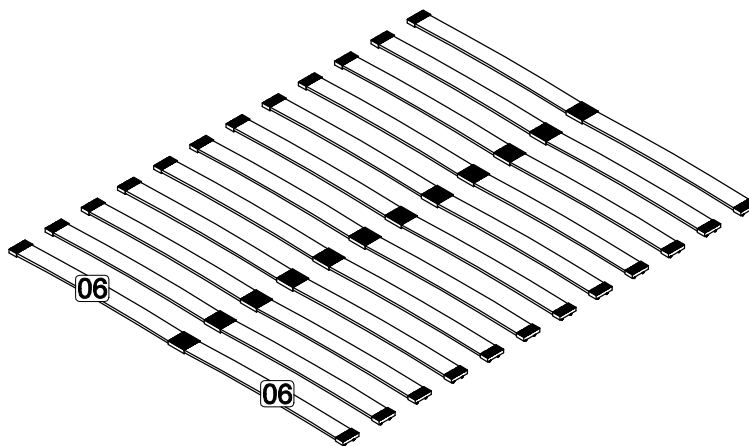
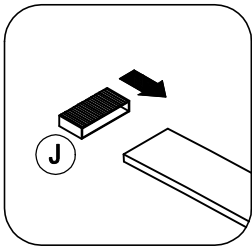

**Birlea**

Suppliers of inspiration

**Step 8:** Assemble hardware J and K onto mounting position on metal center bar (8), bed side (4) and (5) by using hand.  
**DO NOT use any power tools as this may damage the frame and will invalidate any claim.**

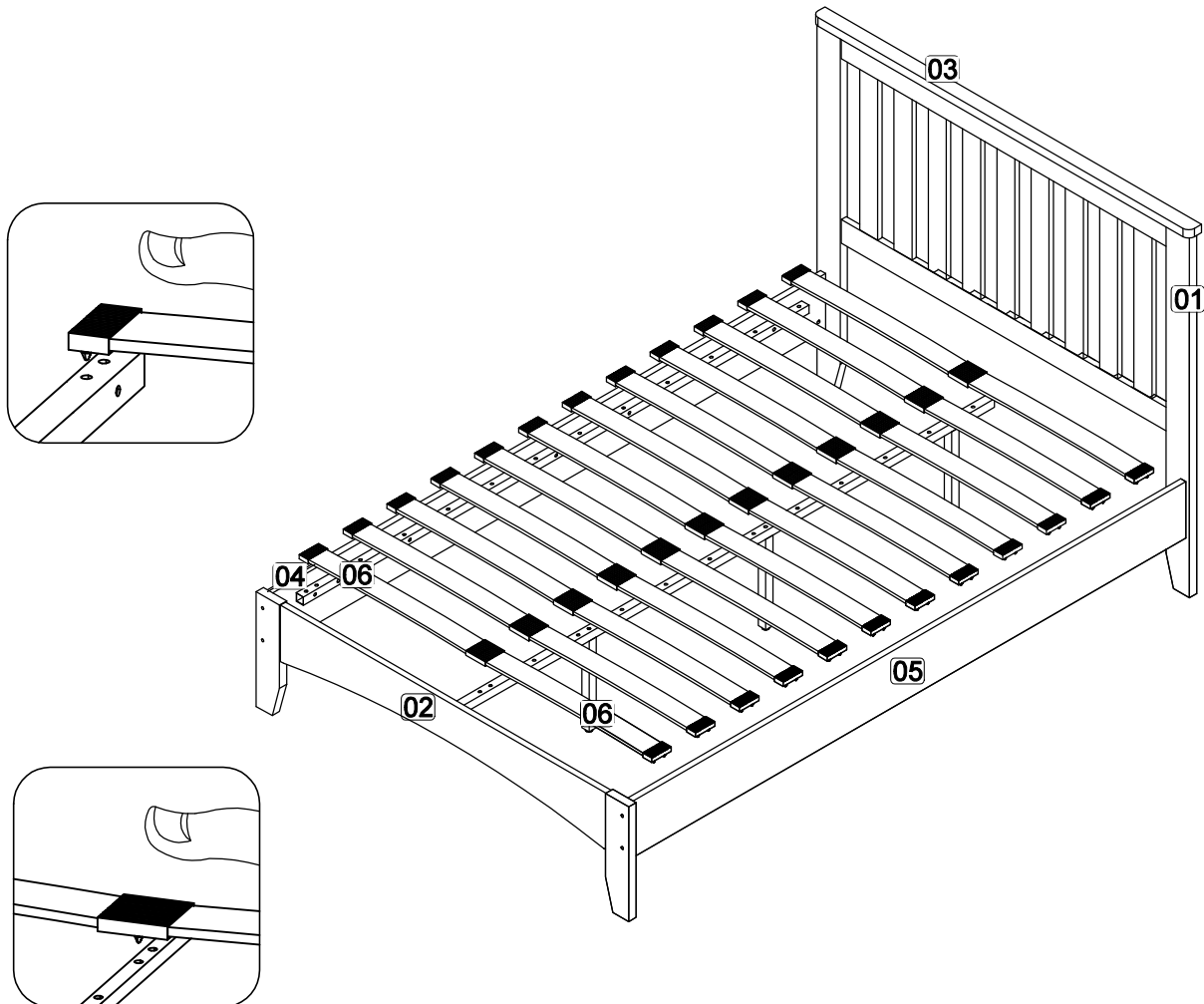

### Additional Information:

- For complete product information, images and dimension diagrams please visit the website [www.birlea.com](http://www.birlea.com)
- If you have any issues with your item please contact the retailer directly you purchased it from who will be able to resolve any issues with Birlea.
- Why don't you send us photos of your assembled furniture to [info@birlea.com](mailto:info@birlea.com) to be shared in our #birleahome feature on instagram.

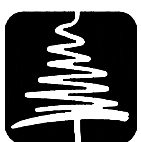

# Birlea

Suppliers of inspiration